

REV.	ECN.NO.	MODIFY.CONTENT	DATE
A		FIRST VERSION	04/11'19

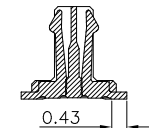
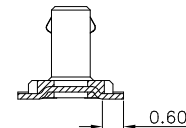
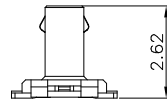
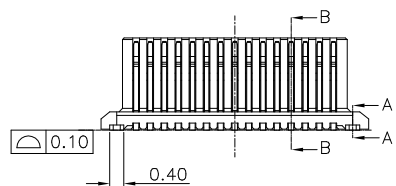
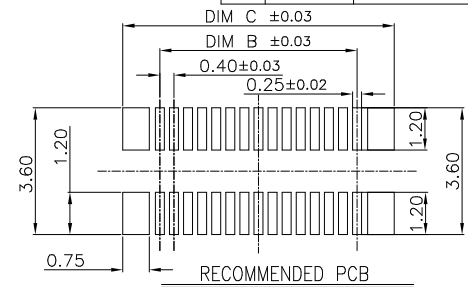
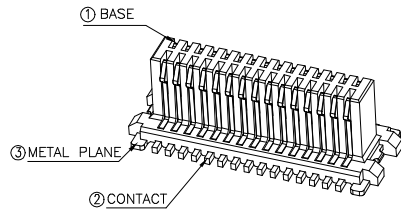
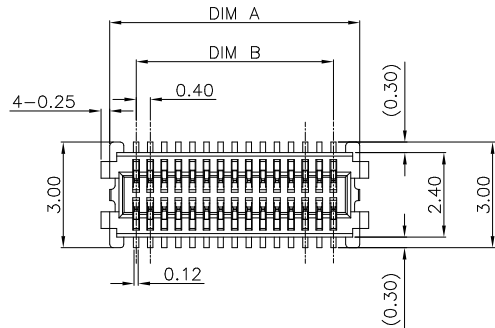

DIM.A	DIM.B	DIM.C	DIM.D	PIN NO.
5.10	3.60	5.70	8.90	20 PIN
7.10	5.60	7.70	10.90	30 PIN
8.30	6.80	8.90	12.10	36 PIN
9.10	7.60	9.70	12.90	40 PIN
11.10	9.60	11.70	14.90	50 PIN
13.10	11.60	13.70	16.90	60 PIN

MATERIALS

Housing :LCP,UL94V-0, Black
 Contact :Brass
 Contact Plating :Gold flash or Tin over Nickel 30~150u"
 Metal Plane : Brass
 Metal Plane Plating : 100~200u" Tin over Nickel 30~150u"

SPECIFICATIONS

Current Rating :0.3A
 Operation Temperature :-40°C to +85°C
 Insulation Resistance :100MΩ Min
 contact resistance :100mΩ Max
 Durability : 30cycles.

PART NO.:

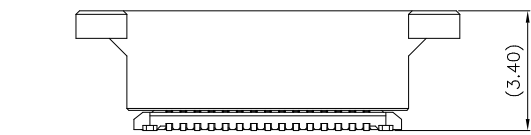
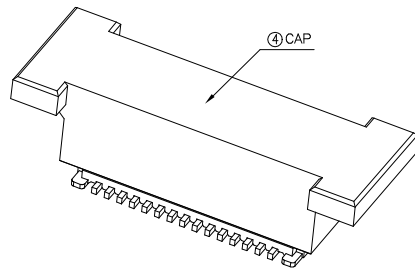
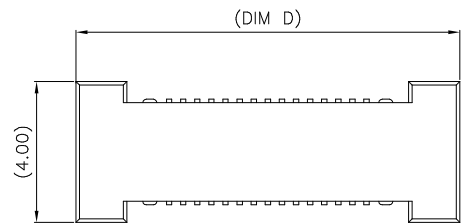
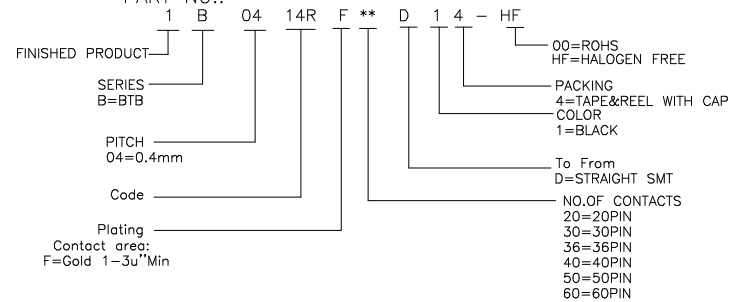

WITH CAP

GENERAL TOLERANCE		DRAWN	Wilson Sun	2019.4.20	SCALE	PART NO.	1B0414RF**D14-HF
X.±0.30	x.'±3.0'	CHECKED	Shengjie Chu	2019.4.20	5/1	TITLE	0.4 PITCH BTB REC
.X±0.25	.x'±2.0'	APPROVED	Cunfa Lai	2019.4.20	UNITS	mm	CUSTOMER DRAWING
.XX±0.20		File NO.	B0414R01S				
.XXX±0.10		REV.					
SHEET	1/1	Q'TY	1	A	蘇州祥龍嘉業電子科技股份有限公司 Goldenconn Electronics Technology Co.,LTD		

此文件为双方检验的唯一标准
 This document is the only standard for inspection by both parties.

REV.	ECN.NO.	MODIFY.CONTENT	DATE
A		FIRST VERSION	04/11' 19

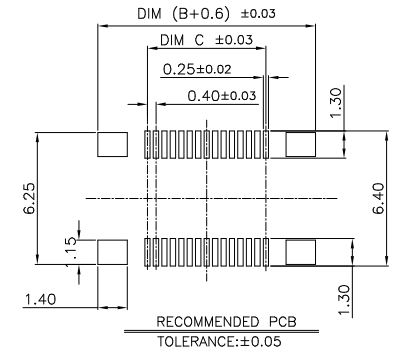
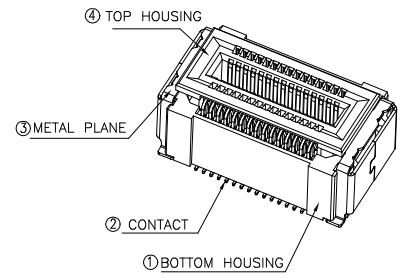
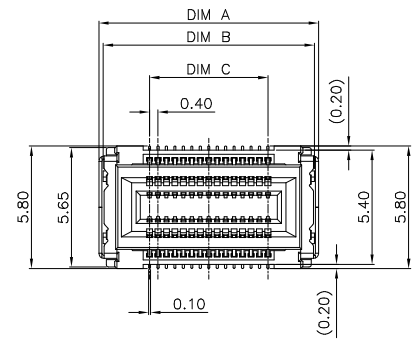

DIM.A	DIM.B	DIM.C	DIM.D	DIM.E	PIN NO.
8.40	8.00	3.60	7.70	10.60	20 PIN
10.40	10.00	5.60	9.70	12.60	30 PIN
11.60	11.20	6.80	10.90	13.80	36 PIN
12.40	12.00	7.60	11.70	14.60	40 PIN
14.40	14.00	9.60	13.70	16.60	50 PIN
16.40	16.00	11.60	15.70	18.60	60 PIN

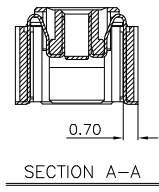
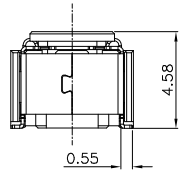
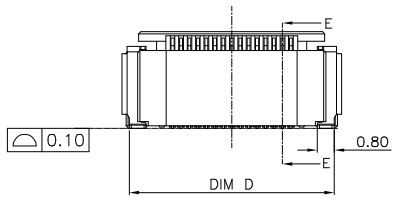

MATERIALS

Housing :LCP,UL94V-0, Black
 Contact :Brass
 Contact Plating :Gold flash or Tin over Nickel 30~150u"
 Metal Plane : Brass
 Metal Plane Plating : 100~200u" Tin over Nickel 30~150u"

SPECIFICATONS

Current Rating :0.3A
 Operation Temperature :-40°C to +85°C
 Insulation Resistance :100MΩ Min
 contact resistance :100mΩ Max
 Durability : 30cycles.

PART NO.:

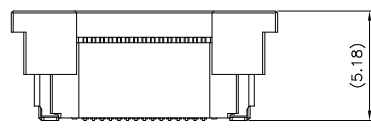
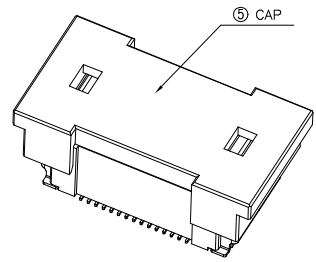
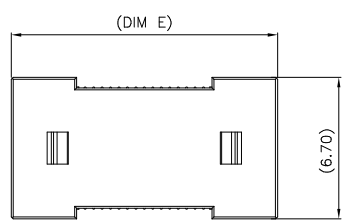
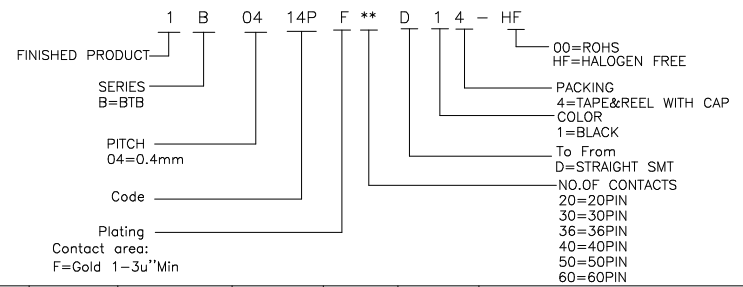

WITH CAP

GENERAL TOLERANCE		DRAWN	Wilson Sun	2019.4.20	SCALE	PART NO.	1B0414PF**D14-HF
X.±0.30	x.*±3.0°	CHECKED	Shengjie Chu	2019.4.20	3/1	TITLE	0.4 PITCH BTB PLUG
.X±0.25	.x*±2.0°	APPROVED	Cunfa Lai	2019.4.20	UNITS	mm	CUSTOMER DRAWING
.XX±0.20		File NO.	B0414P01S				
.XXX±0.10		REV.					

此文件为双方检验的唯一标准
 This document is the only standard for inspection by both parties.

蘇州祥龍嘉業電子科技股份有限公司
 Goldenconn Electronics Technology Co.,LTD

SHEET	1/1	Q'TY	1	A
-------	-----	------	---	---